

**UNIT 101** (737 S.F.)

SCALE: 1/8" = 1' - 0"  
 (SIMILAR UNITS: 301, 401)



ACTUAL SQUARE FOOTAGE MAY VARY.

<p>101</p>	<p><b>EAGLE STREET MILLS</b>          11 EAGLE STREET          PROVIDENCE, RHODE ISLAND</p>	<p><b>BRADY SULLIVAN</b>          PROPERTIES          670 NORTH COMMERCIAL STREET SUITE 303          MANCHESTER, NEW HAMPSHIRE 03101          TEL: 603-622-6223</p>
------------	---	---

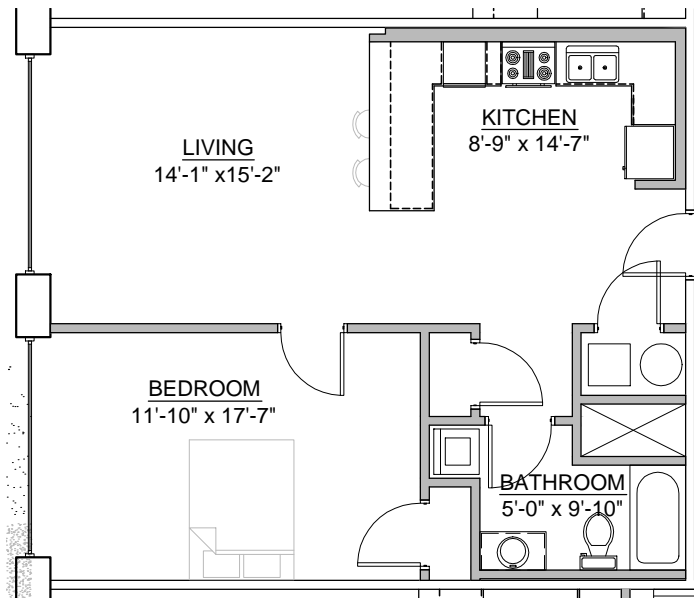

**UNIT 143** (800 S.F.)

SCALE: 1/8" = 1' - 0"  
 (SIMILAR UNITS: 243, 343, 443)

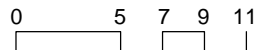

ACTUAL SQUARE FOOTAGE MAY VARY.

<p>143</p>	<p><b>EAGLE STREET MILLS</b>          11 EAGLE STREET          PROVIDENCE, RHODE ISLAND</p>	 670 NORTH COMMERCIAL STREET SUITE 303 MANCHESTER, NEW HAMPSHIRE 03101 TEL: 603-622-6223
------------	---	---

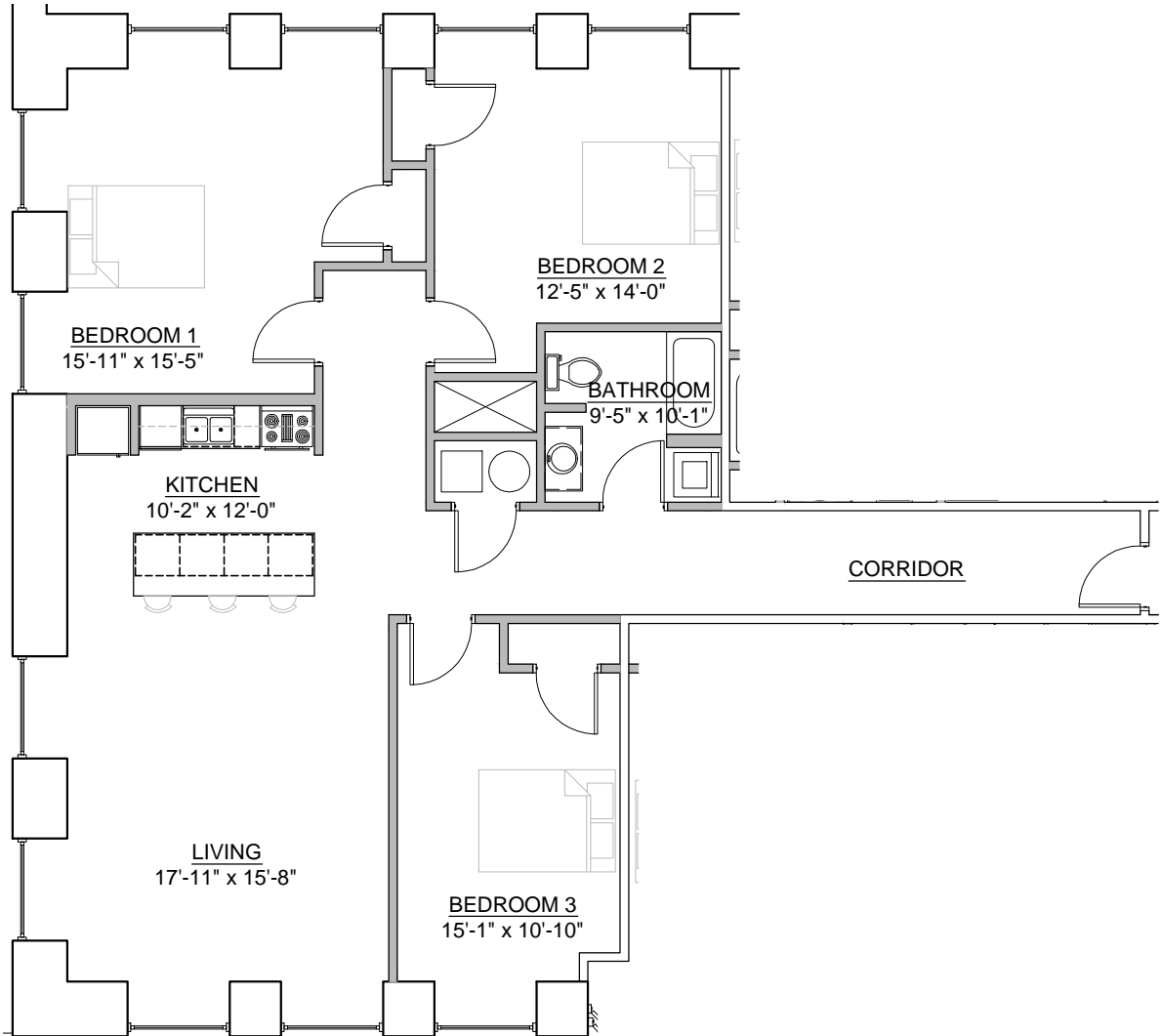

**UNIT 154** (1441 S.F.)

SCALE: 1/8" = 1' - 0"  
 (SIMILAR UNITS: 256, 354, 454)

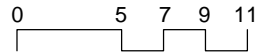

ACTUAL SQUARE FOOTAGE MAY VARY.

<p><b>154</b></p>	<p><b>EAGLE STREET MILLS</b>          11 EAGLE STREET          PROVIDENCE, RHODE ISLAND</p>	<p><b>BRADY SULLIVAN</b>  <small>REALTY</small>          870 NORTH COMMERCIAL STREET SUITE 303          MANCHESTER, NEW HAMPSHIRE 03101          TEL: 603-622-6223</p>
-------------------	---	--

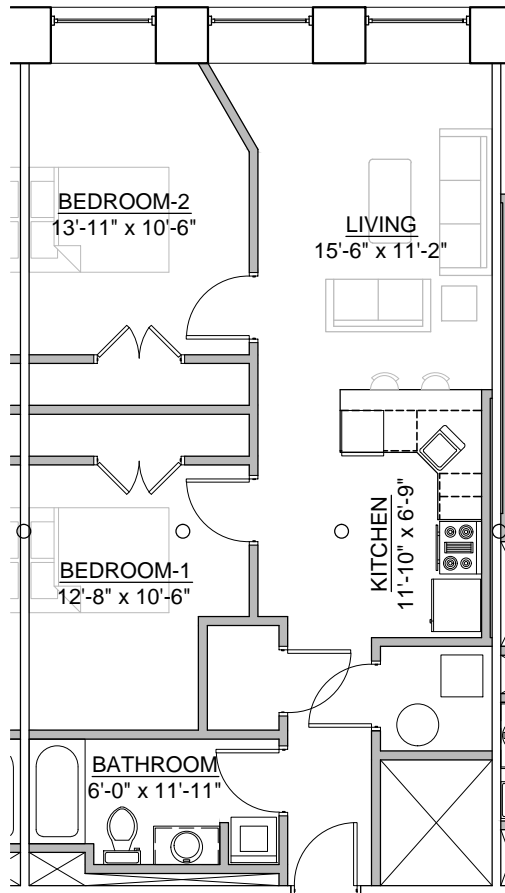

**UNIT 227** (829 S.F.)

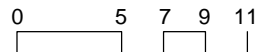

SCALE: 1/8" = 1' - 0"

(SIMILAR UNITS: 231, 235, 327, 331, 335, 427, 431, 435)

ACTUAL SQUARE FOOTAGE MAY VARY.

**227**

**EAGLE STREET MILLS**  
 11 EAGLE STREET  
 PROVIDENCE, RHODE ISLAND

**BRADY SULLIVAN**  
 PROPERTIES  
 670 NORTH COMMERCIAL STREET SUITE 303  
 MANCHESTER, NEW HAMPSHIRE 03101  
 TEL: 603-622-6223

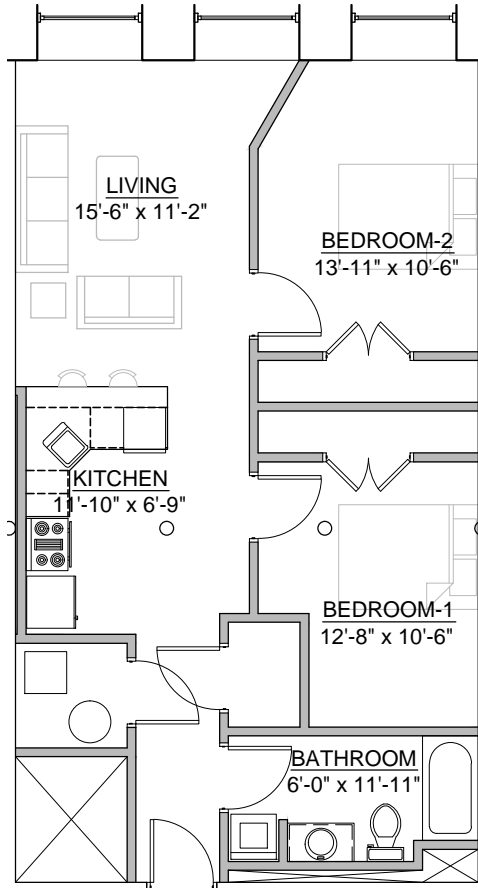

**UNIT 229** (866 S.F.)

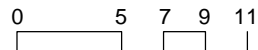

SCALE: 1/8" = 1' - 0"  
 (SIMILAR UNITS: 233, 329, 333, 429, 433)

ACTUAL SQUARE FOOTAGE MAY VARY.

<p>229</p>	<p><b>EAGLE STREET MILLS</b>          11 EAGLE STREET          PROVIDENCE, RHODE ISLAND</p>	<p><b>BRADY SULLIVAN</b>          PROPERTIES          670 NORTH COMMERCIAL STREET SUITE 303          MANCHESTER, NEW HAMPSHIRE 03101          TEL: 603-622-6223</p>
------------	---	---

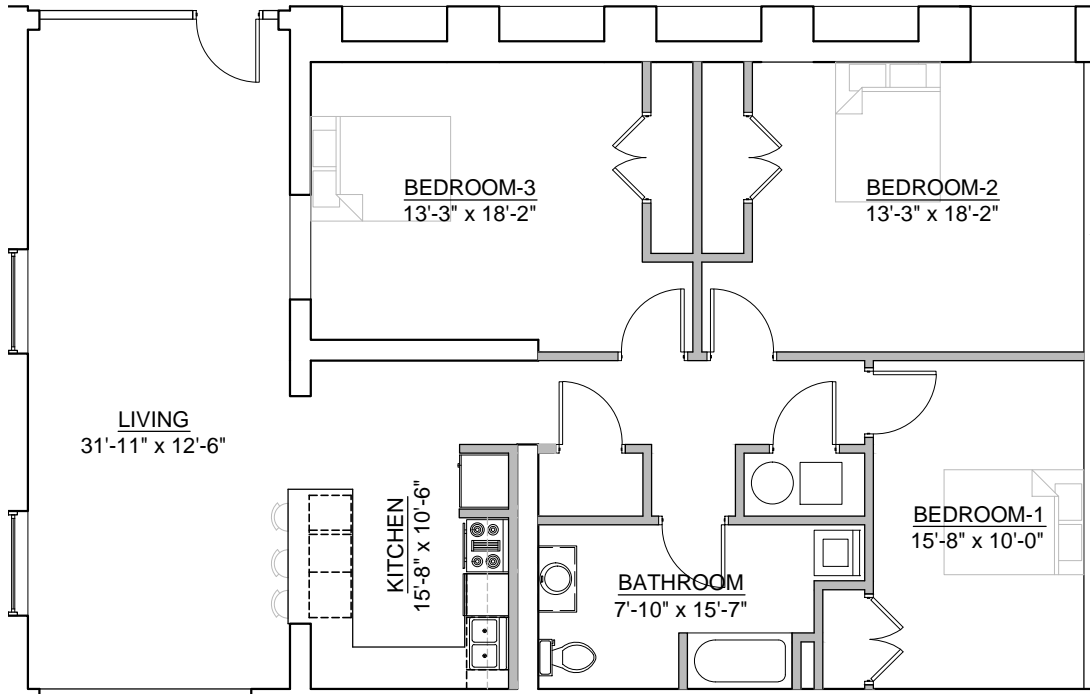

**UNIT 232** (1532 S.F.)

SCALE: 1/8" = 1' - 0"

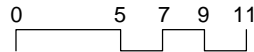

ACTUAL SQUARE FOOTAGE MAY VARY.

<p><b>232</b></p>	<p><b>EAGLE STREET MILLS</b>          11 EAGLE STREET          PROVIDENCE, RHODE ISLAND</p>	<p><b>BRADY SULLIVAN</b>          REALTY          670 NORTH COMMERCIAL STREET SUITE 303          MANCHESTER, NEW HAMPSHIRE 03101          TEL: 603-622-6223</p>
-------------------	---	---

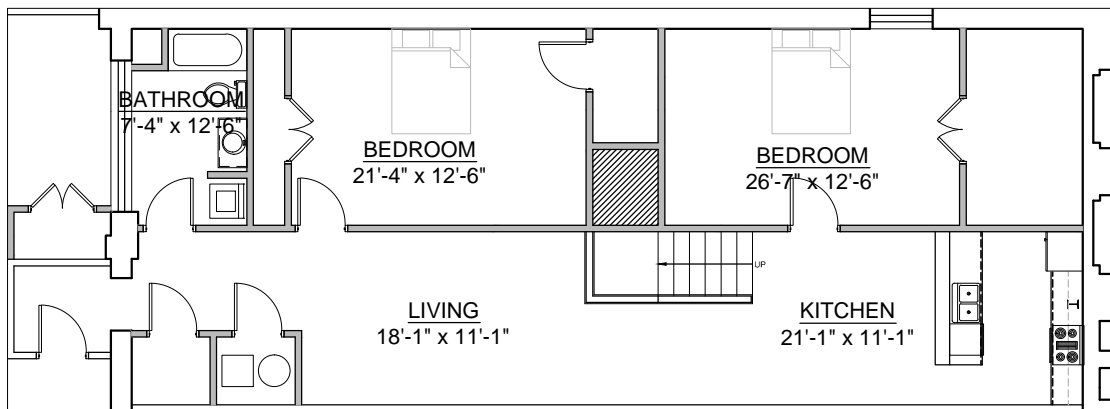
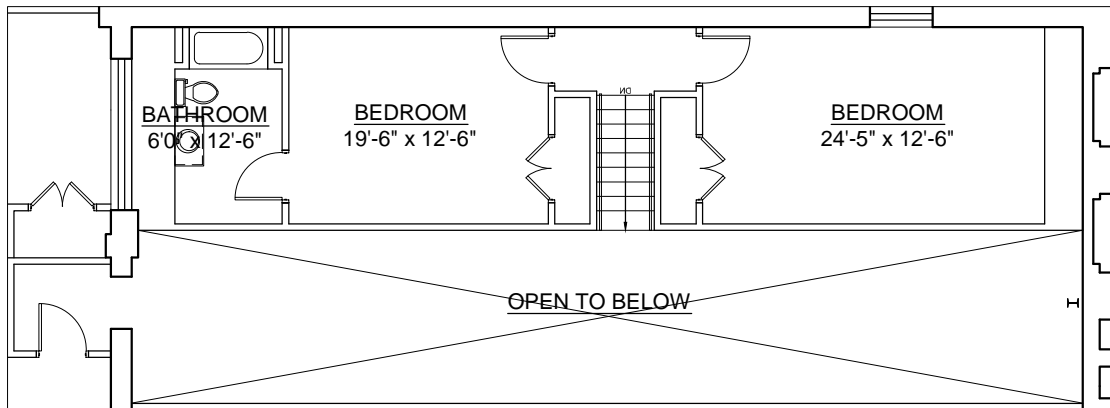

**UNIT 234** (1489 SF + 692 M)

SCALE: 3/32" = 1' - 0"

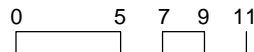

ACTUAL SQUARE FOOTAGE MAY VARY.

<p><b>234</b></p>	<p><b>EAGLE STREET MILLS</b> 11 EAGLE STREET PROVIDENCE, RHODE ISLAND</p>	<p><b>BRADY SULLIVAN</b> PROPERTIES 670 NORTH COMMERCIAL STREET SUITE 303 MANCHESTER, NEW HAMPSHIRE 03101 TEL: 603-622-6223</p>
-------------------	---	---

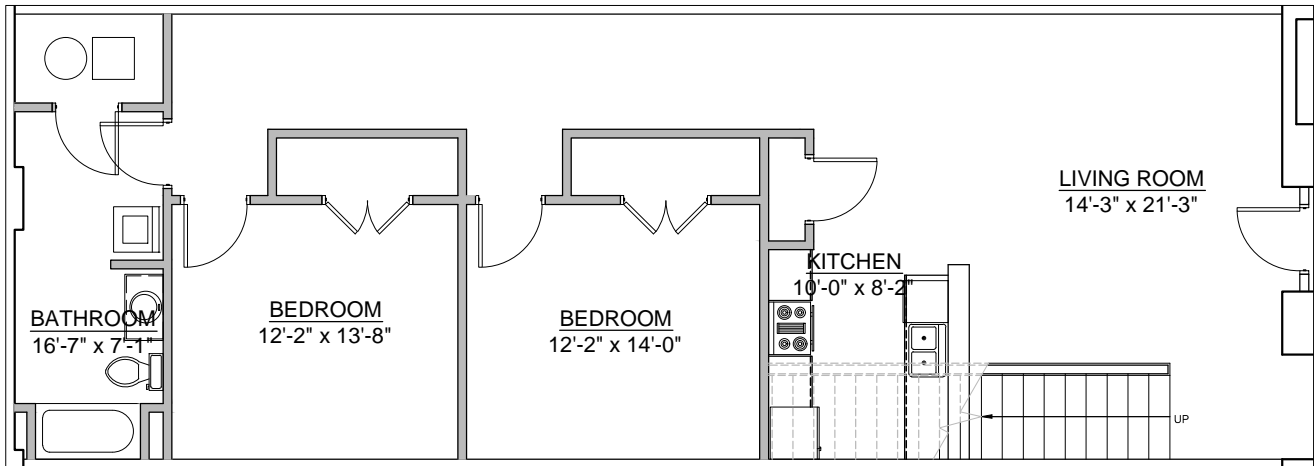
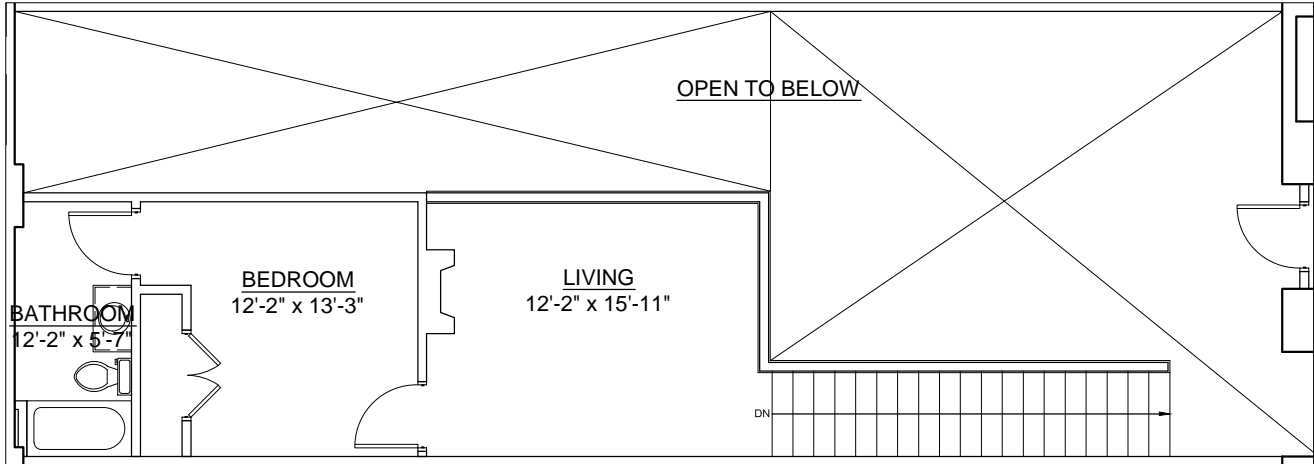

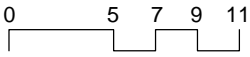
**UNIT 240** (1286 SF + 444 SF)
 

SCALE: 1/8" = 1' - 0"

ACTUAL SQUARE FOOTAGE MAY VARY.

<p>240</p>	<p><b>EAGLE STREET MILLS</b>          11 EAGLE STREET          PROVIDENCE, RHODE ISLAND</p>	 <small>670 NORTH COMMERCIAL STREET SUITE 303          MANCHESTER, NEW HAMPSHIRE 03101          TEL: 603-622-6223</small>
------------	---	--